

NOTES:

MATERIAL:
STEEL WITH 2.0mm LEAD EQUIVALENCE

PAD PRINT COLOR:
2.0mm LEAD EQUIVALENCE GLASS

FRAME COLOR:
TAN

NOT TO SCALE

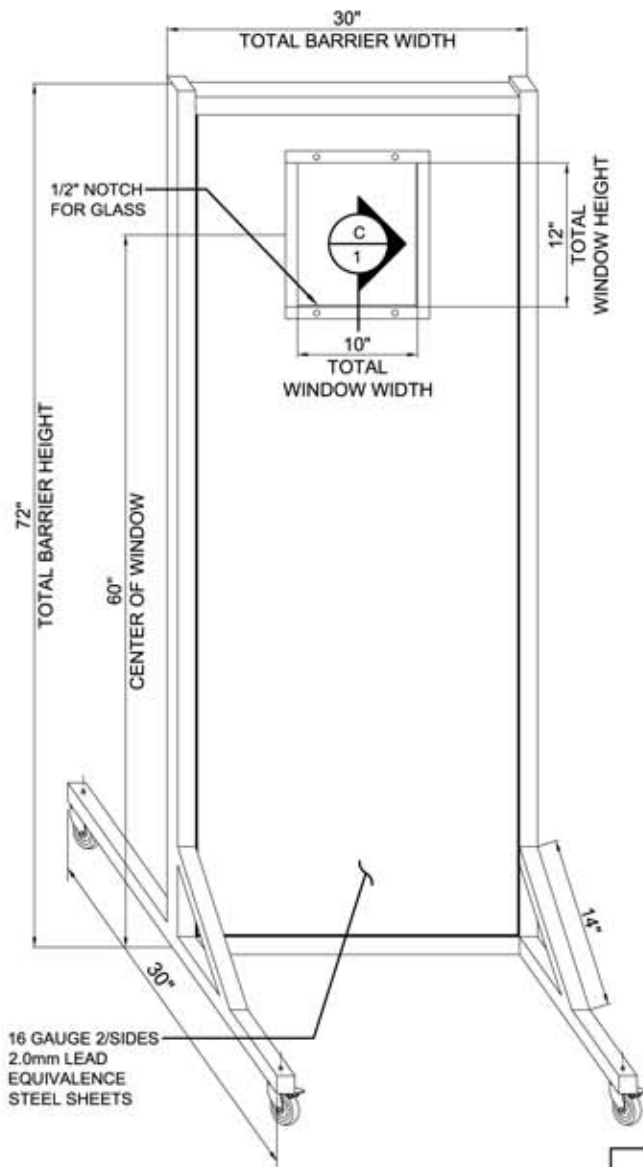

(A) BARRIER ELEVATION
1

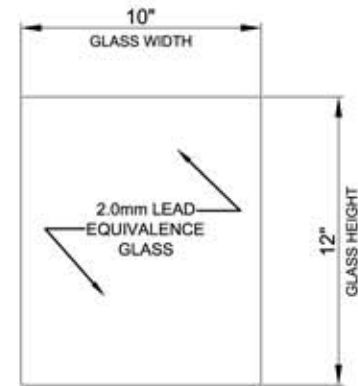

(B) GLASS ELEVATION
1

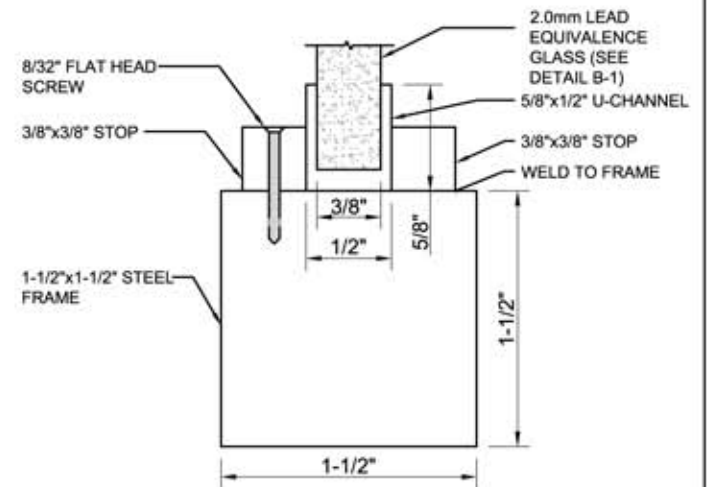

(C) SECTION AT FRAME
1



123 LINCOLN BOULEVARD
MIDDLESEX, NJ 08846
732-356-1493

DWG No.

LB-3072

Rev.

P/N:

LB-3072

DESC.

Opaque Mobile Leaded Barrier
30 in. x 72 in

ANY AND ALL INFORMATION CONTAINED IN/ON THIS DRAWING IS THE PROPERTY OF PHILLIPS SAFETY PRODUCTS INC. AND SHALL NOT BE USED OR DISCLOSED TO A THIRD PARTY WITHOUT PRIOR WRITTEN CONSENT OF PHILLIPS SAFETY PRODUCTS INC.